

Scharfer

Professional LED power supplies



Model: **SCH-100-12** Size: 218*40*22mm
SCH-100-24



Brief Information

SSS
Super Slim Series

100W

Waterproof Power Supply (C.V.)

Model SCH-100-12 / SCH-100-24

Input 170-250V AC

Output 12V DC 8.33A 100W / 24V DC 4.17A 100W

Product Features

- Compact size, easy for installation
- High transfer efficiency
- Stable constant voltage output
- IP67, both indoor & outdoor use suitable
- 100% full loading, 100% burn-in tested
- Overload/short circuit protection

MAIN ELECTRICAL DATA

AC Input

Input Voltage	170-250V
Input Frequency	50/60Hz
Efficiency (Typ.)	90%
Input Current	230V: 0.9A _{max.}
Inrush Current	40A
Leakage Current	5mA/230VAC

DC Output

Output Voltage	12V	24V
Rated Current	8.33A	4.17A
Rated Power	100W	100W
Ripple & Noise (Max.)	<100mVp-p	<100mVp-p
Setup, Rise Time	1500ms/230VAC	1500ms/230VAC
Line Regulation	1%	1%
Load Regulation	1%	1%

Service Environment

Working Temp.	-30°C~50°C
Working Humidity	20~95%RH
Storage Temp.	-40°C~80°C
Storage Humidity	10~95%RH

Protection

Overload	Yes, cut-off mode, output shuts down if 10-20% over-loaded
Short Circuit	Yes, hiccup mode, recovers automatically after fault condition is removed

Safety

Safety Standard	EN 61347-2-13
Withstand Voltage	I/P-O/P: 3000VAC/1min/<5mA
Isolation Resistance	I/P-O/P: >100M Ohms / 500VDC /25°C / 70%RH

Packaging Information

Product Dimension	218*40*22mm
Products Net Weight	390G
PCS/Carton(QTY)	40 PCS
Master Carton Size	37*26*26cm
G. Weight/ Carton	17KG

Installation Tips:

- Please identify the power supply's input and output before installation.
- Ensure correct output + & - wire connection. Power on after wire connection is done.
- To avoid voltage drop and loading capacity wasting on the output extension wire, please install the power supply to the loading as near as possible, if must use long extension wires, thicker wires and less loading wattage is required.
- The power supply to be installed at good ventilation and cooling environment.

Scharfer

Professional LED power supplies

Physical Drawing

Unit: mm

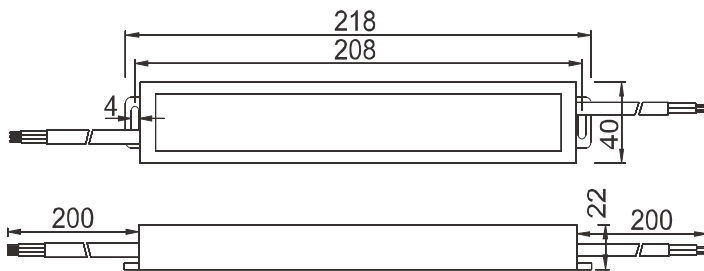

Brief Information

SSS
Super Slim Series

100W

Waterproof Power Supply (C.V.)

Model SCH-100-12 / SCH-100-24

Input 170-250V AC

Output 12V DC 8.33A 100W / 24V DC 4.17A 100W

Input: 3x0.75mm² wire, Brown L, Blue N
200mm length

Output: 2x1mm² wire, Red +, Black -
200mm length

Housing: Aluminium

Block Diagram

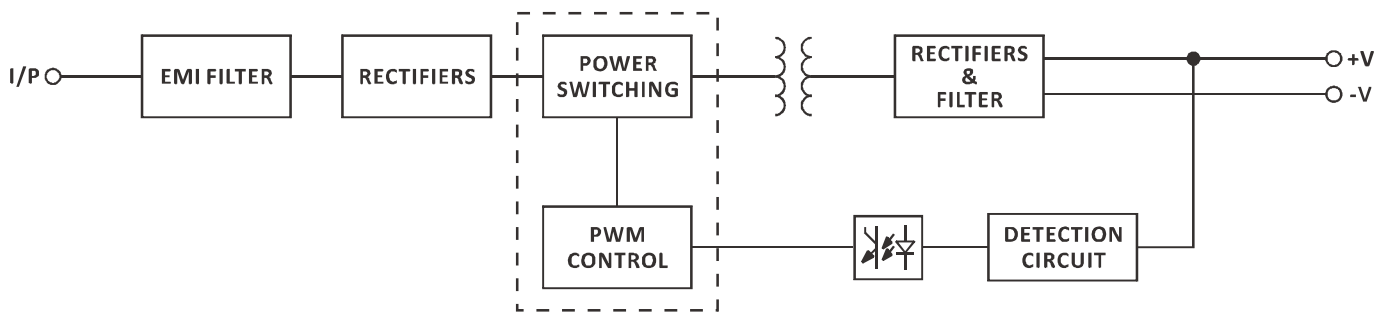

Derating Curve

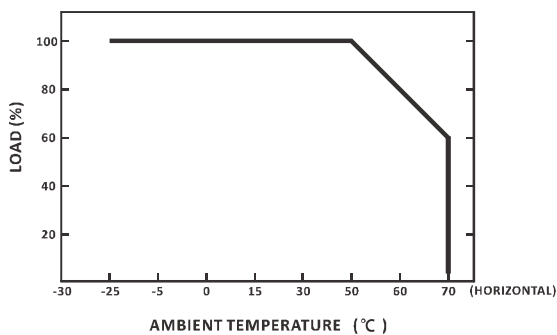

Static Characteristics

